



FA-4 series

Medium pressure, in line spin-on filters

Technical Information



Housing

Pressure: Max working (acc. to NFPA T 3.10.17):

FA-4-1x: 34,5 bar (500 psi)

FA-4-21: 24 bar (348 psi)

Burst (acc. to NFPA T 3.10.17):

FA-4-1x: 69 bar (1000 psi)

FA-4-21: 55 bar (798 psi)

Fatigue Test (acc. to NFPA T 3.10.17):

FA-4-1x: 0 / 34,5 bar (0 / 500 psi)

FA-4-21: 0 / 24 bar (0 / 348 psi)

Connection Ports: 3/4" ÷ 1 1/4" BSP (other thread options on request)

Materials: Head: aluminium alloy
Bowl: carbon steel + aluminium alloy
Seal: NBR (FKM on request)

By-pass: 3,5 bar (50 psi)

Element

Filter Media: Microglass fiber 4,5 - 7 - 12 - 18 - 27 - 40 $\mu\text{m}_{(c)}$ (acc. to ISO 16889)
Cellulose 10 - 25 $\mu\text{m}_{(c)}$ (acc. to ISO 16889)

Differential collapse pressure: (acc. to ISO 2941)
FA-4-1x: 15 bar (218 psi)
FA-4-21: 12 bar (174 psi)

Filtrec elements are tested also according to ISO 2942, ISO 23181 and ISO 3968

Common

Working temperature: -25°C +120°C (-13°F +248°F)

Fluid compatibility (acc. to ISO 2943):

Full with HH-HL-HM-HV (acc. to ISO 6743/4).

For use with other fluid applications please contact Filtrec Customer Service (info@filtrec.it).

Ordering information

MEDIA	
000	no element
G03	microglass fiber $\beta_{4,5 \mu\text{m (c)}} \geq 1000$
G06	microglass fiber $\beta_{7 \mu\text{m (c)}} \geq 1000$
G10	microglass fiber $\beta_{12 \mu\text{m (c)}} \geq 1000$
G15	microglass fiber $\beta_{18 \mu\text{m (c)}} \geq 1000$
G25	microglass fiber $\beta_{27 \mu\text{m (c)}} \geq 1000$
G40	microglass fiber $\beta_{40 \mu\text{m (c)}} \geq 1000$
C10	cellulose $\beta_{10 \mu\text{m (c)}} \geq 2$
C25	cellulose $\beta_{25 \mu\text{m (c)}} \geq 2$

	NOMINAL SIZE	MEDIA	SEALS	CONNECTION	BY-PASS	INDICATOR
Filter assembly FA-4	21	C10	V	B6	D	Z34
Filter element A-4	21	C10	V			

SEALS	
B	NBR
V	FKM

CONNECTION	
B4	3/4" BSP
B5	1" BSP
B6	1 1/4" BSP

For different thread options please check availability with Filtrec Customer Service.

BY-PASS	
0	no by-pass
D	3,5 bar / 50,7 psi

INDICATOR	
000	no indicator
Z00	indicator port plugged
Z34	differential visual 2,7 bar/ 39 psi
Z35	differential electric switch 2,7 bar/ 39 psi

Overall dimensions

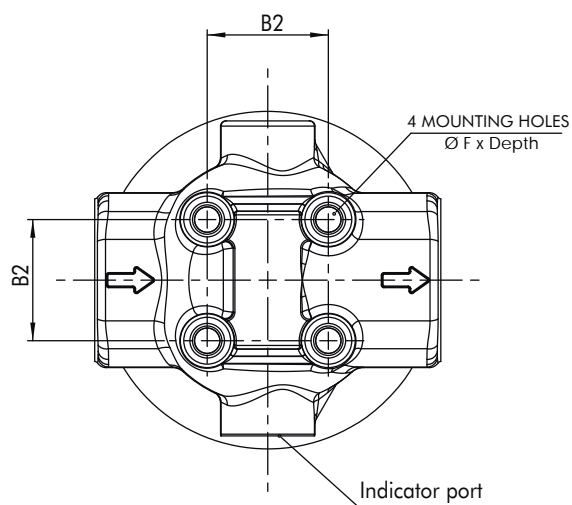
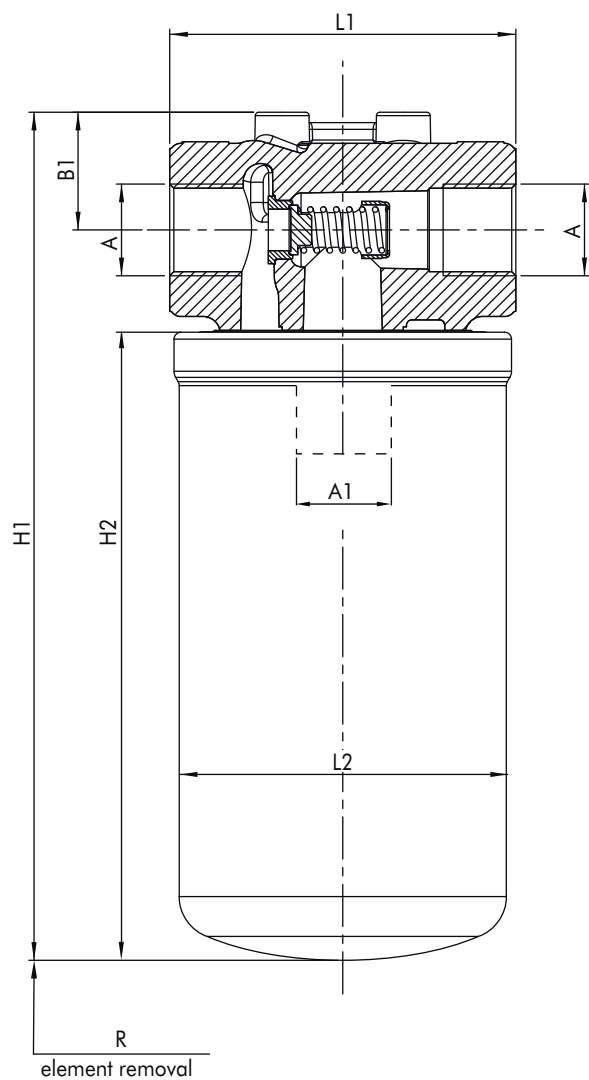

Nominal size

CODE	A	B1	B2	F	H1	L1	R	WEIGHT	ELEMENT	H2	A1	L2
FA-4-05	3/4" 1" BSP	34	35	M10x15	165	100	30	1,6 Kg	A-4-05	100	1 3/8-12 UN 2B	97
FA-4-11					216			1,8 Kg	A-4-11	152		
FA-4-12					245			1,9 Kg	A-4-12	180		
FA-4-13					302			2,2 Kg	A-4-13	240		
FA-4-21	1 1/4" BSP	40	48		369	121		3,2 Kg	A-4-21	295	1 3/4-12 UN 2B	120

For different thread options please contact Filtrac Customer Service.

FA-4 series

Pressure drop diagrams

The total Pressure Drop (Δp) value is obtained by adding the Δp values of filter housing and filter element at the given flow rate. This ideally should not exceed 1,0 bar (14,5 psi) and should never exceed 1/3 of the set value of the by-pass valve.

PRESSURE DROP THROUGH THE FILTER HOUSING

The Pressure Drop through the filter housing is governed by the port, not the bowl length and the oil viscosity.

PRESSURE DROP THROUGH THE CLEAN FILTER ELEMENT

The Pressure Drop through the filter element is related both to the internal diameter of the filter element and to the filter media; this value is affected by the oil viscosity in a roughly proportional way: e.g. when the Dp value from the curve is 0,2 bar and a 46 cSt oil is used, the corresponding value is 0,31 ($=0,2 \times 46/30$) bar.

Housing FA-4

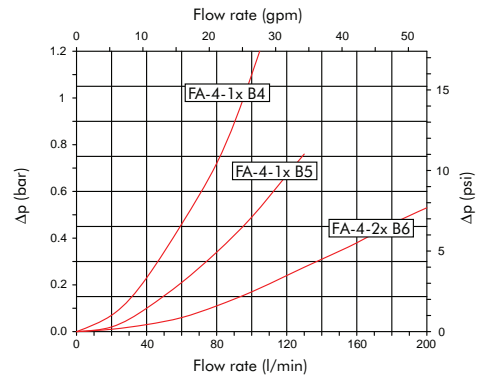

Element A-4-05

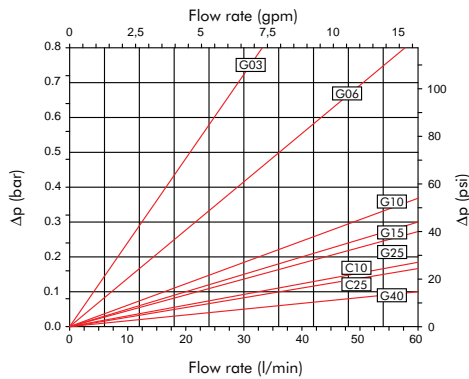

Element A-4-11

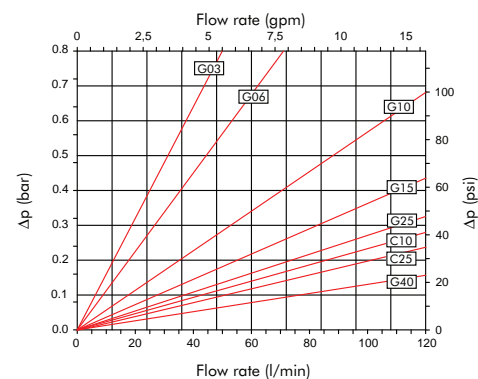

Element A-4-12

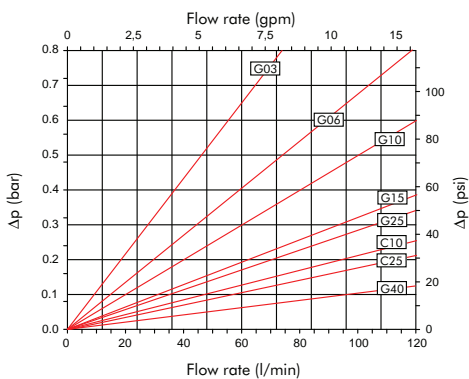

Element A-4-13

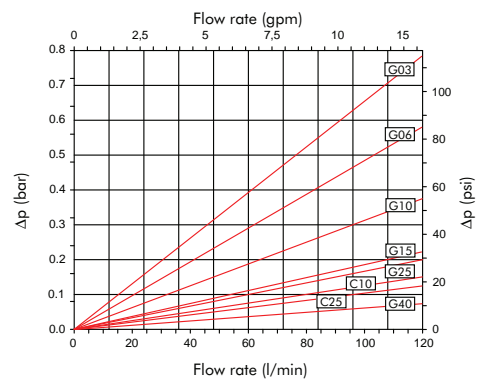

Element A-4-21

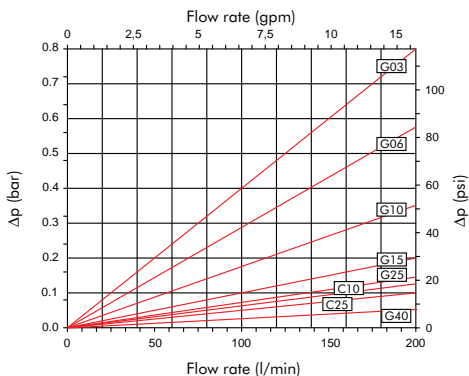

Pressure drop diagrams

The total Pressure Drop (Δp) value is obtained by adding the Δp values of filter housing and filter element at the given flow rate. This ideally should not exceed 1,0 bar (14,5 psi) and should never exceed 1/3 of the set value of the by-pass valve.

PRESSURE DROP THROUGH THE BY-PASS VALVE

The by-pass valve is a safety device to prevent element collapse in case of differential pressure peaks due to flow peaks, cold start conditions or when the clogged element is not replaced in a timely manor.

By-pass FA-4

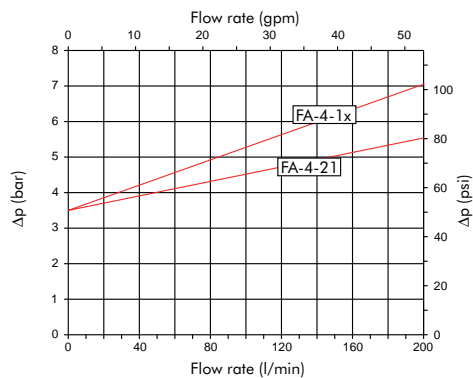

The above diagrams have been obtained at the FILTREC laboratory, according to the ISO 3968 specification, with mineral oil having 30 cSt viscosity and 0,86 Kg/dm³ density.

In case of discrepancy, please check contamination level, viscosity and features of the oil in use and the sampling points of the differential pressure.

Clogging indicator

The Pressure Drop (Δp) through the filter increases during the system operation due to the contaminant retained by the filter element.

The filter element must be replaced when the indicator shows an alarm and before the Δp reaches the by-pass value setting.

N.B. in cold start conditions a false alarm can be caused by higher oil viscosity due to low temperature; the indicator alarm must be considered at normal working temperature only.

The differential clogging indicator registers the pressure upstream and downstream the filter element and activates a signal when the differential pressure reaches the set value:

- in the VISUAL indicator the signal is given by a green sector switching into red.
- in the ELECTRIC indicator an electrical switch is activated.

N.B. the set value of the clogging indicator must always be lower than the set value of the by-pass valve.



DIFFERENTIAL VISUAL SWITCH

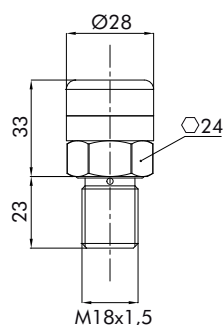

SYMBOL

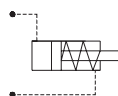

CODE	SETTING
Z34	2,7 bar (39 psi)

Visual indicator:

- GREEN: clean element
- RED: dirty element



DIFFERENTIAL ELECTRIC SWITCH

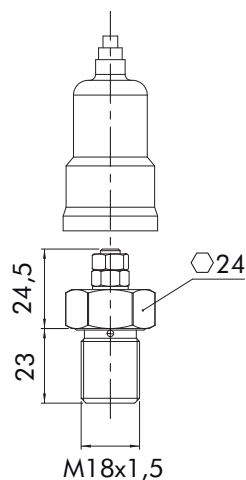

SYMBOL

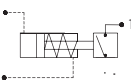

CODE	SETTING
Z35	2,7 bar (39 psi)

- Max current: 0,5A resistive / 0,2A inductive
- Max voltage: 36 VDC
- Protection: IP54 as per DIN 40050

User Tips

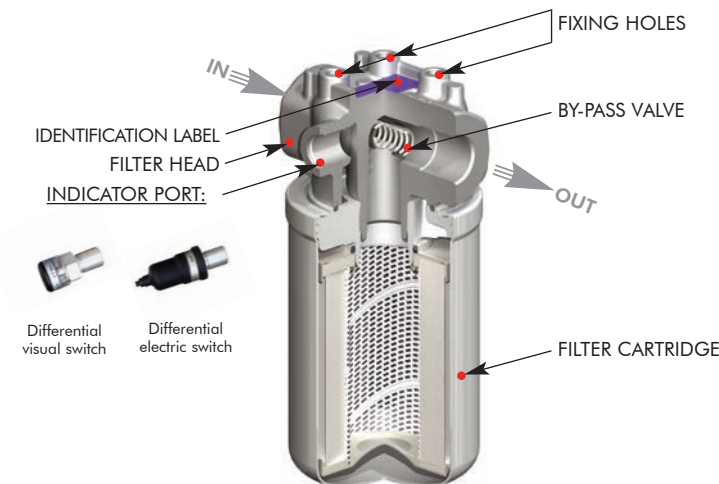

BOWL TIGHTENING TORQUE	
FA-4-xx	1/2 turn

INDICATOR TIGHTENING TORQUE	
Z34/Z35	90 Nm

Installation

Make sure that the filter head is connected in the correct IN-OUT flow direction (shown by an arrow on the filter head).

The filter assembly should be preferably mounted with the cartridge downward; the filter head must be properly secured using the threaded fixing holes on the filter head; verify that no tension is present on the filter after mounting.

Make sure that enough space is available for cartridge (filter element) replacement and that the clogging indicator is in a easily viewable position. If an electrical indicator is used, make sure that it is properly wired. Never run the system without the cartridge fitted. We recommend the stocking of a spare FILTREC cartridge for timely replacement when required.

Maintenance

Before unscrewing the cartridge, ensure that the system is switched off and there is no residual pressure in the filter.

Unscrew the cartridge by turning it anticlockwise. Verify the correct part number of the FILTREC replacement cartridge, particularly concerning the micron rating. Ensure that the mounting face is clean, lubricate the gasket and the thread on the replacement cartridge prior to assembly. Spin on new cartridge until it reaches the mounting face and tighten for 1/2 turn.

Operation

Make sure that the filter works within the conditions of pressure, temperature and fluid compatibility given in the first page of this data sheet. The cartridge (filter element) must be replaced as soon as the clogging indicator signals at working temperature (in cold start conditions, oil temperature lower than 30°C, a false alarm can be given due to oil viscosity). If no clogging indicator is mounted, make sure that the cartridge is replaced according to instructions on the ca or to the system manufacturer's recommendations.

PED Compliance

FA-4 filters conform to PED 97/23/CE norm, article 3 section 3, and so they can be used with fluids of group 2 (liquids with steam pressure < 0,5 bar at the maximum allowable temperature, article 3, section 1.1(b) – sub-section II).

WARNING

Make sure that Personal Protective Equipment (PPE) is worn during installation and maintenance operation.

Disposal of filter elements

The used filter elements and the filter parts dirty of oil are classified as "Dangerous waste material": they must be disposed according to the local laws by authorized Companies.



FA-4 series

www.filtrec.com

