



F280-D1 series

In line medium pressure filters



Technical Information

Housing

Pressure: Max working 280 bar (4000 psi) (acc. to NFPA T 3.10.5.1)
Burst 840 bar (12200 psi) (acc. to NFPA T 3.10.5.1)

Connection Ports: 1/2" ÷ 1 1/2" BSP (other thread options on request)

Materials: Head: cast iron
Bowl: extruded steel
Seal: Buna-N (FKM on request)

By-pass: No by-pass or 6 bar (90 psi) setting

Element

Filter Media: Microglass fiber 4,5 - 7 - 12 - 18 - 27 $\mu\text{m}_{(c)}$ (acc. to ISO 16889)
Cellulose 10 $\mu\text{m}_{(c)}$ (acc. to ISO 16889)

Differential collapse pressure:
21 bar (300 psi) or 210 bar (3000 psi) (acc. to ISO 2941)

Filtrec elements are tested also according to ISO 2942 and ISO 23181

Common

Working temperature: -25°C +120°C (-13°F +248°F)

Fluid compatibility (acc. to ISO 2943):
Full with HH-HL-HM-HV (acc. to ISO 6743/4).
For use with other fluid applications please contact Filtrec Customer Service (info@filtrec.it).

Ordering information

MEDIA	
000	no element
G03	microglass fiber $\beta_{4,5 \mu\text{m (c)}} \geq 1000$
G06	microglass fiber $\beta_{7 \mu\text{m (c)}} \geq 1000$
G10	microglass fiber $\beta_{12 \mu\text{m (c)}} \geq 1000$
G15	microglass fiber $\beta_{18 \mu\text{m (c)}} \geq 1000$
G25	microglass fiber $\beta_{27 \mu\text{m (c)}} \geq 1000$
*C10	cellulose $\beta_{10 \mu\text{m (c)}} \geq 2$

*Only for Δp 21 bar (300 psi)

	NOMINAL SIZE	MEDIA	ELEMENT COLLAPSE	SEALS	CONNECTION	BY-PASS	INDICATOR PORT OPTION	INDICATOR
Filter assembly F280-D1	20	G10	A	V	B3	D	S	Z30
Filter element D1	20	G10	A	V				

ELEMENT COLLAPSE	
A	21 bar / 300 psi
*B	210 bar / 3000 psi

* recommended with no by-pass option.

SEALS	
B	NBR
V	FKM

CONNECTION	
B3	1/2" BSP
B4	3/4" BSP
B5	1" BSP
B6	1 1/4" BSP
B7	1 1/2" BSP

For different thread options please check availability with Filtrac Customer Service.

BY-PASS	
0	no by-pass
D	6 bar / 90 psi

INDICATOR PORT OPTION	
*0	no indicator port
S	indicator port with plug
*T	indicator port on the right side with plug

* Optional, please check availability with Filtrac Customer Service.

INDICATOR	
000	no indicator
Z30	differential visual 5 bar/ 70 psi
Z31	differential electrical visual 5 bar/ 70 psi
Z32	differential visual 8 bar/ 120 psi
Z33	differential electrical visual 8 bar/ 120 psi

TO BE USED WITH NO BY-PASS OPTION ONLY

Overall dimensions

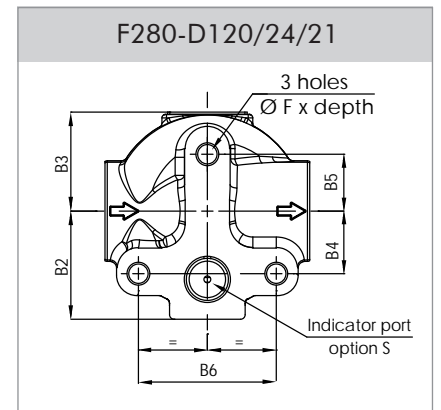
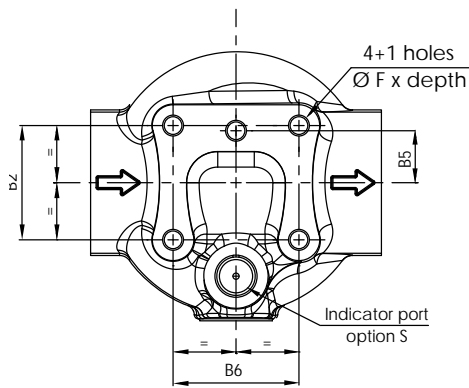
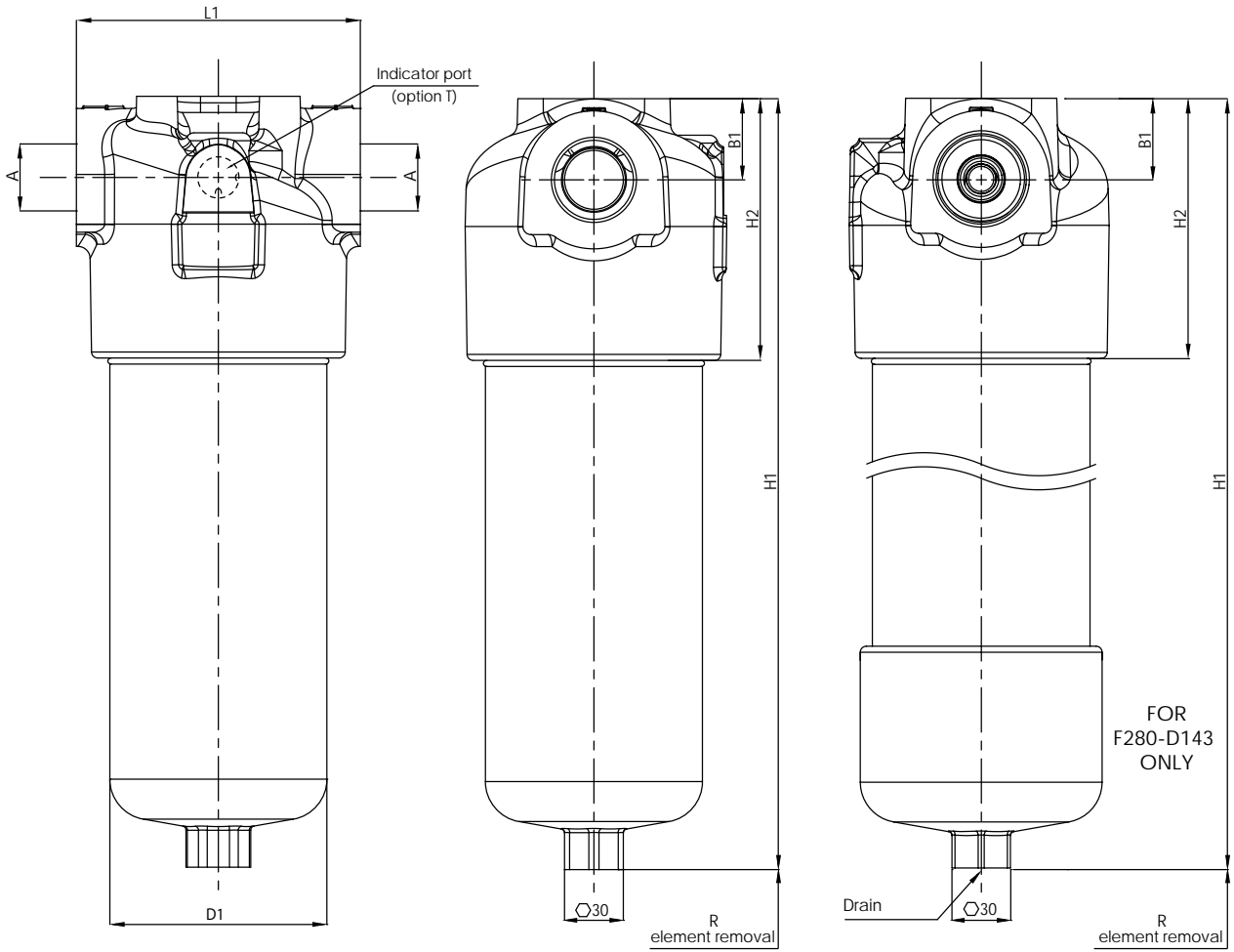

Nominal size

CODE	A	B1	B2	B3	B4	B5	B6	D1	F	H1	H2	L1	R	WEIGHT
F280-D120	1/2" BSP									200				3,5 Kg
F280-D124	3/4" BSP	22,5	47,5	43,5	27,5			70		243	92	90	110	4,5 Kg
F280-D121	1" BSP									293				4,2 Kg
F280-D140						25	60,6		M10x15	248				9,5 Kg
F280-D141	1 1/4" BSP	40	55	--	--			107		341	129	140	130	9,0 Kg
F280-D142	1 1/2" BSP									461				14,4 Kg
F280-D143										554				18,8 Kg

For different thread options please contact Filtrac Customer Service.

Pressure drop diagrams

The total Pressure Drop (Δp) value is obtained by adding the Δp values of filter housing and filter element at the given flow rate. This ideally should not exceed 1,0 bar (14,5 psi) and should never exceed 1/3 of the set value of the by-pass valve.

PRESSURE DROP THROUGH THE FILTER HOUSING

The Pressure Drop through the filter housing is governed by the port, not the bowl length and the oil viscosity.

PRESSURE DROP THROUGH THE CLEAN FILTER ELEMENT

The Pressure Drop through the filter element is related both to the internal diameter of the filter element and to the filter media; this value is affected by the oil viscosity in a roughly proportional way: e.g. when the D_p value from the curve is 0,2 bar and a 46 cSt oil is used, the corresponding value is 0,31 ($=0,2 \times 46/30$) bar.

Housing F280-D120/24/21

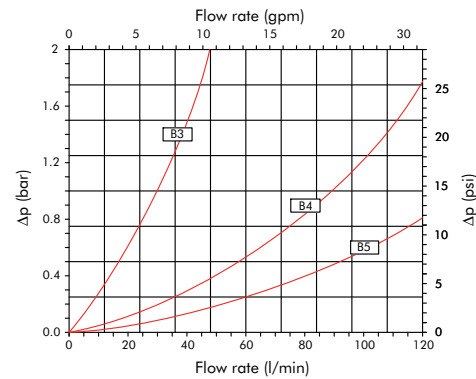

Element D120...-A

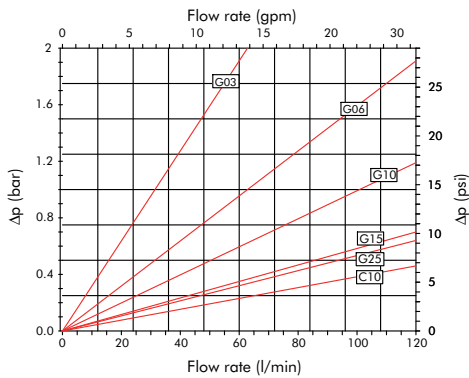

Element D120...-B

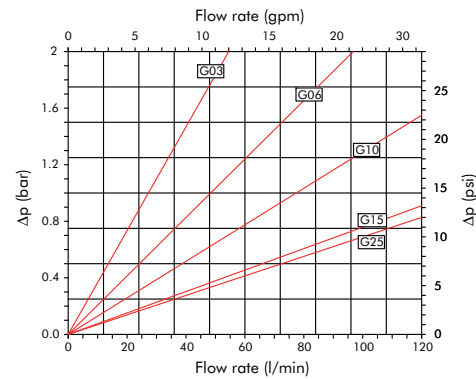

Element D124...-A

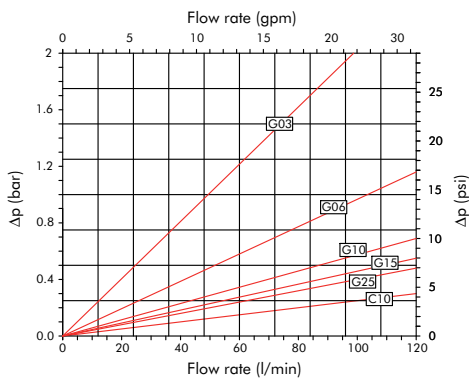

Element D124...-B

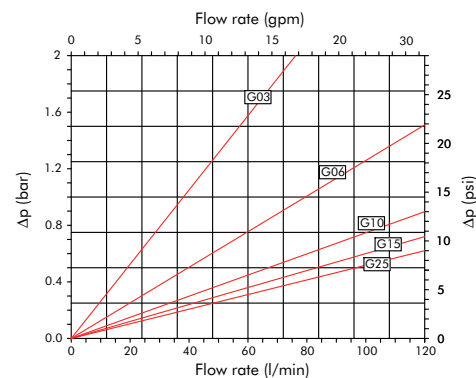

Element D121...-A

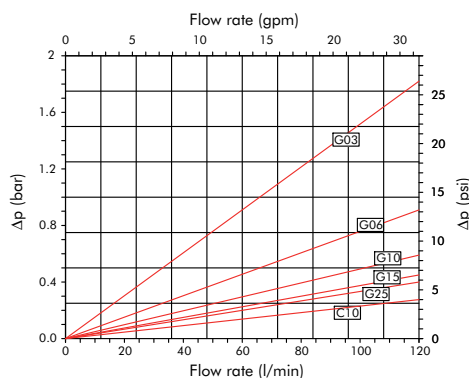

Element D121...-B

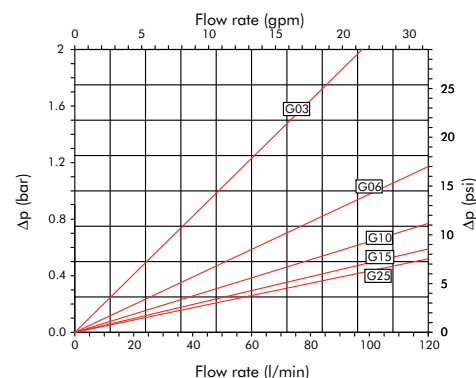

Pressure drop diagrams

The total Pressure Drop (Δp) value is obtained by adding the Δp values of filter housing and filter element at the given flow rate. This ideally should not exceed 1,0 bar (14,5 psi) and should never exceed 1/3 of the set value of the by-pass valve.

PRESSURE DROP THROUGH THE FILTER HOUSING

The Pressure Drop through the filter housing is governed by the port, not the bowl length and the oil viscosity.

PRESSURE DROP THROUGH THE CLEAN FILTER ELEMENT

The Pressure Drop through the filter element is related both to the internal diameter of the filter element and to the filter media; this value is affected by the oil viscosity in a roughly proportional way: e.g. when the Dp value from the curve is 0,2 bar and a 46 cSt oil is used, the corresponding value is 0,31 ($=0,2 \times 46/30$) bar.

Housing F280-D140/41/43

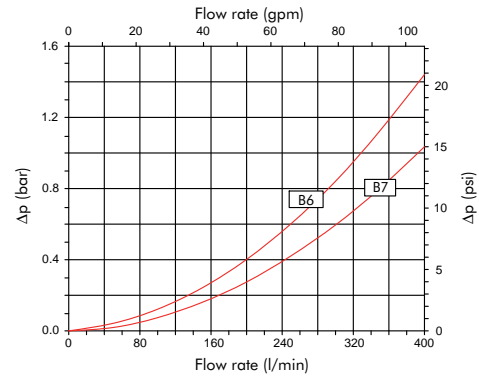

Element D140...-A

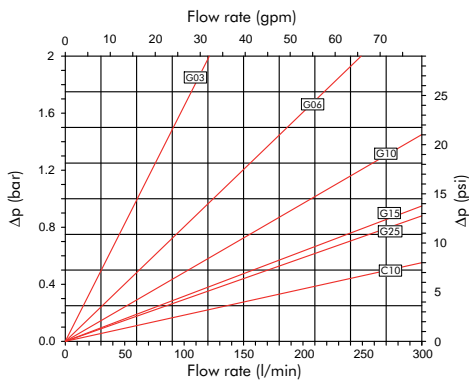

Element D140...-B

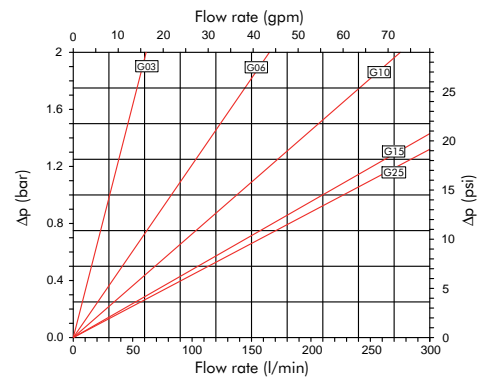

Element D141...-A

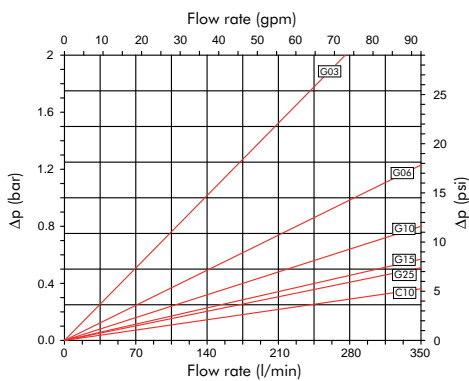

Element D141...-B

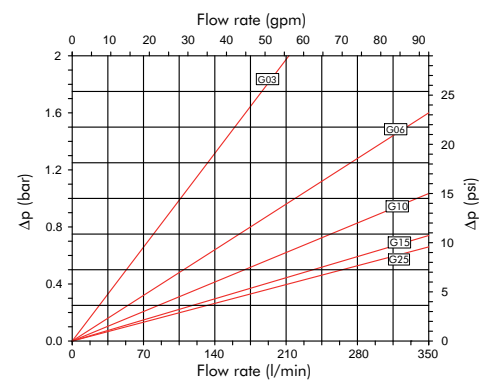

Element D142...-A

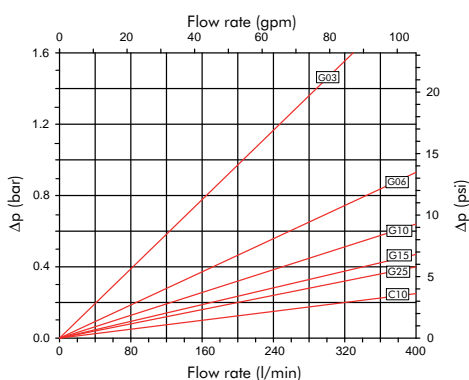

Element D142...-B

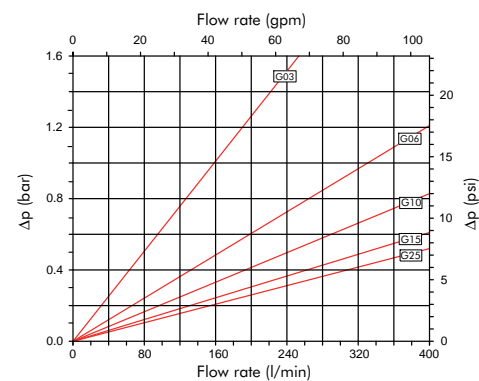

Pressure drop diagrams

The total Pressure Drop (Δp) value is obtained by adding the Δp values of filter housing and filter element at the given flow rate. This ideally should not exceed 1,0 bar (14,5 psi) and should never exceed 1/3 of the set value of the by-pass valve.

Element D143---A

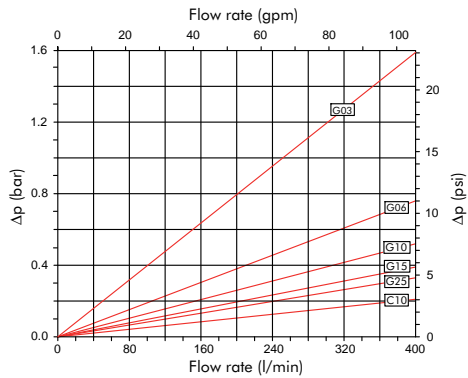

Element D143---B

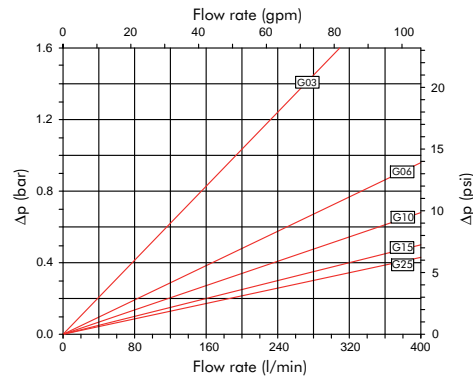

PRESSURE DROP THROUGH THE BY-PASS VALVE

The by-pass valve is a safety device to prevent element collapse in case of differential pressure peaks due to flow peaks, cold start conditions or when the clogged element is not replaced in a timely manner.

By-pass F280-D120/24/21

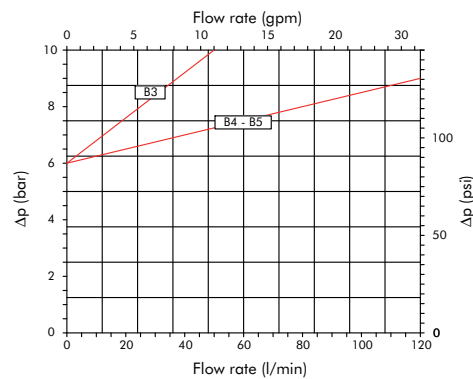

By-pass F280-D140/41/43

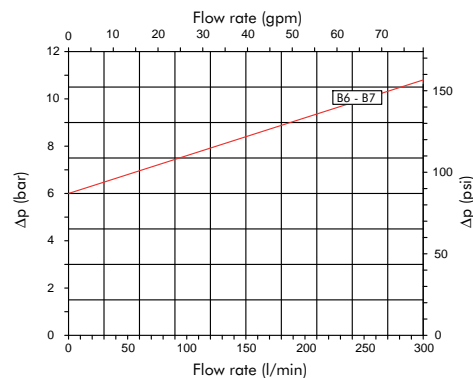

The above diagrams have been obtained at the FILTREC laboratory, according to the ISO 3968 specification, with mineral oil having 30 cSt viscosity and 0,86 Kg/dm³ density.

In case of discrepancy, please check contamination level, viscosity and features of the oil in use and the sampling points of the differential pressure.

Clogging indicator

The Pressure Drop (Δp) through the filter increases during the system operation due to the contaminant retained by the filter element.

The filter element must be replaced when the indicator shows an alarm and before the Δp reaches the by-pass value setting.

N.B. in cold start conditions a false alarm can be caused by higher oil viscosity due to low temperature; the indicator alarm must be considered at normal working temperature only.

The differential clogging indicator registers the pressure upstream and downstream the filter element and activates a signal when the differential pressure reaches the set value:

- in the VISUAL indicator the signal is given by a green sector switching into red.
- in the ELECTRIC VISUAL indicator, further to the green to red visual indication, an electrical switch is activated.

N.B. the set value of the clogging indicator must always be lower than the set value of the by-pass valve.



DIFFERENTIAL VISUAL

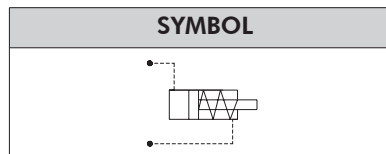
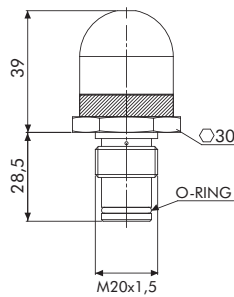

CODE	SETTING
Z30	5 bar (70 psi)
Z32	8 bar (120 psi)

Visual indicator:

- GREEN: clean element
- RED: dirty element



DIFFERENTIAL ELECTRIC VISUAL

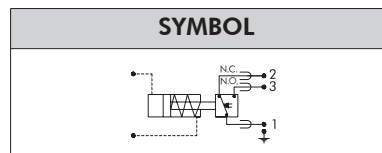
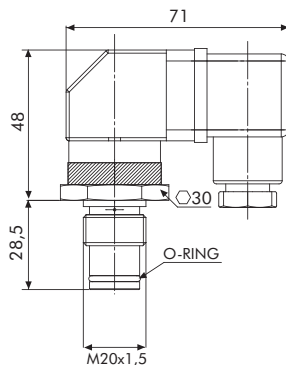

CODE	SETTING
Z31	5 bar (70 psi)
Z33	8 bar (120 psi)

- Visual indicator:
 - GREEN: clean element
 - RED: dirty element
- Electric plug connection as per DIN 43650
- Protection: IP65 acc. to DIN 40050
- Max current: 5A resistive 1A inductive
- Max voltage: 250V AC - 30V DC

User Tips

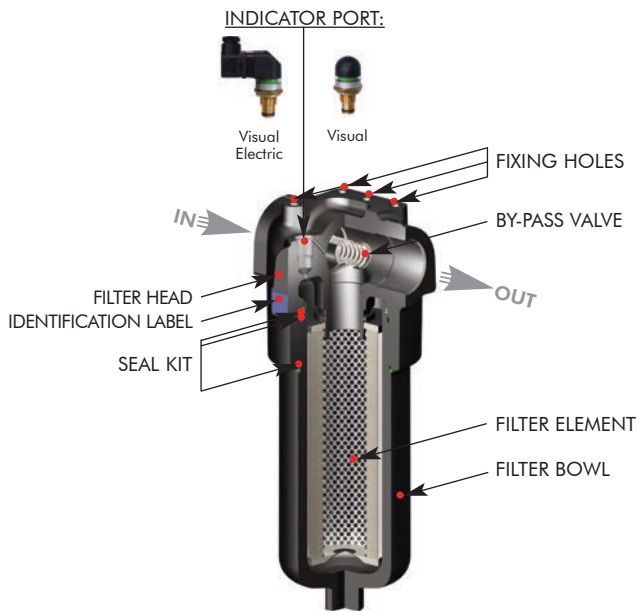

SPARE SEAL KIT PART NUMBER		
	NBR	FKM
F280-D120/24/21	06.021.00090	06.021.00135
F280-D140/41/43	06.021.00095	06.021.00137

BOWL TIGHTENING TORQUE	
F280-D120/24/21	65 Nm
F280-D140/41/43	90 Nm

INDICATOR TIGHTENING TORQUE	
Z30/Z31/Z32/Z33	90 Nm

Installation

Make sure that the filter is connected in the correct IN-OUT flow direction (shown by an arrow on the filter head).

The filter housing should be preferably mounted with the bowl downward; the filter head should be properly secured using the threaded fixing holes on the filter head; verify that no tension is present on the filter after mounting.

Make sure that enough space is available for element replacement and that the clogging indicator is in a easily viewable position. If an electrical indicator is used, make sure that it is properly wired.

Never run the system without a filter element fitted. We recommend the stocking of a spare FILTREC filter element for timely replacement when required.

Operation

Make sure that the filter works within the conditions of pressure, temperature and fluid compatibility given in the first page of this data sheet.

The filter element must be replaced as soon as the clogging indicator signals at working temperature (in cold start conditions, oil temperature lower than 30°C, a false alarm can be given due to oil viscosity).

If no clogging indicator is mounted, make sure that the filter element is replaced according to the system manufacturer's recommendations.

Maintenance

Before opening the filter housing, ensure that the system is switched off and there is no residual pressure in the filter.

Unscrew the bowl by turning it anticlockwise.

Remove the dirty filter element pulling it carefully; replace it with a FILTREC element, verifying the part number, particularly concerning the micron rating. When fitting the new element, open the plastic protection on the top and insert the element over the spigot in the filter head, then remove completely the plastic protection.

Clean carefully the bowl; check the gaskets conditions and replace if necessary; lubricate the threads and screw by hand the bowl in the filter head by turning it clockwise. Tighten at the recommended torque.

N.B. The used filter elements cannot be cleaned and re-used.

PED Compliance

F280-D1 filters conform to PED 97/23/CE norm, article 3 section 3, and so they can be used with fluids of group 2 (liquids with steam pressure < 0,5 bar at the maximum allowable temperature, article 3, section 1.1(b) – sub-section II).

WARNING

Make sure that Personal Protective Equipment (PPE) is worn during installation and maintenance operation.

Disposal of filter elements

The used filter elements and the filter parts dirty of oil are classified as "Dangerous waste material": they must be disposed according to the local laws by authorized Companies.

